

Overpressure Leak Detector

DLR-P ../CV

Documentation DLR-P ../CV

No.: 604 222
Issue: 04/2015

SGB GMBH
Hofstraße 10
57076 Siegen
GERMANY



Overview of designs variants

The overpressure leak detectors of the DLR-series are available in different designs which are described in detail by the suffix characters.

DLR-... .. /CVPM

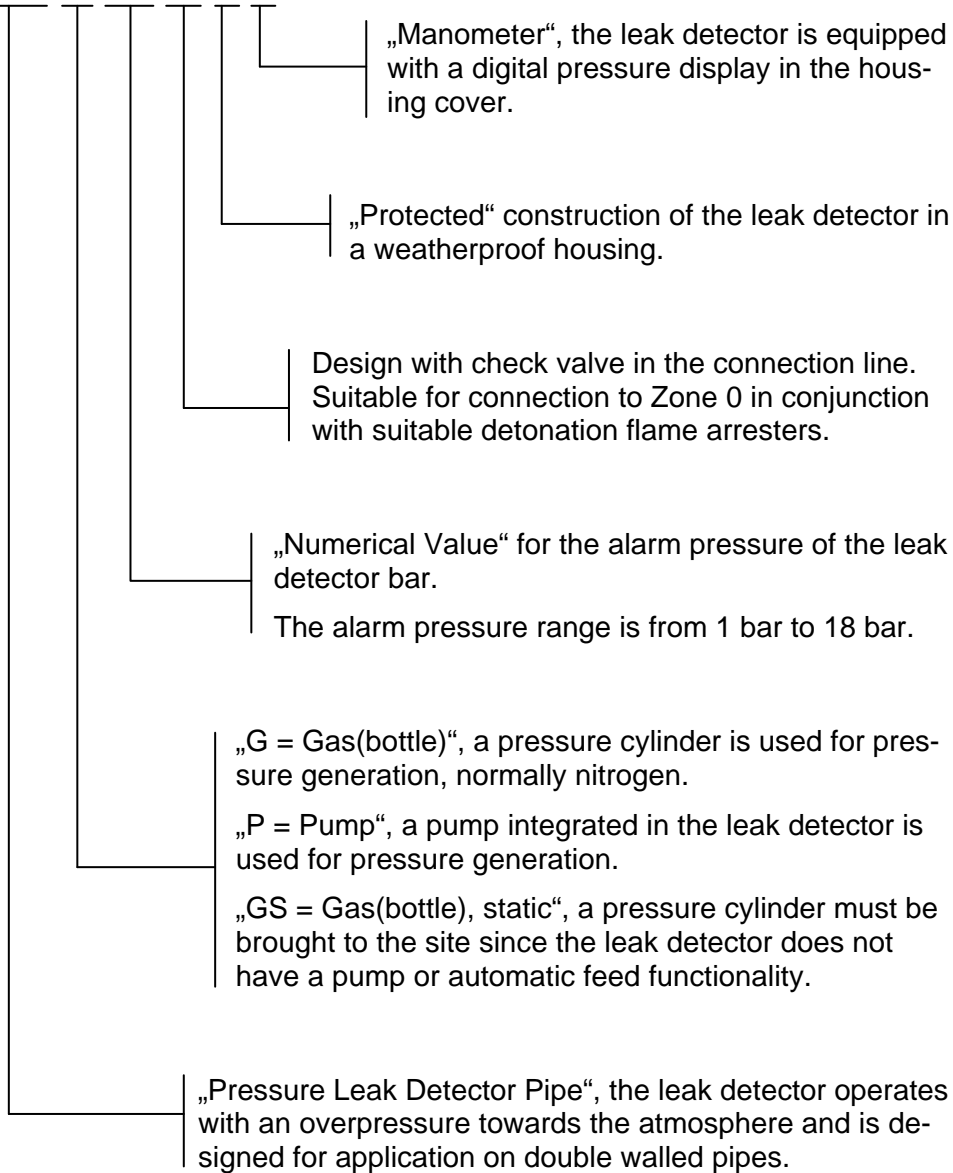



Content

1	Technical description for the overpressure leak detector DLR-P	13 pages
2	Drawings to the technical description	6 pages
3	Appendix to the technical description Appendix TD Appendix TF Appendix DP Statement	4 pages
4	Measurement and Drilling	2 pages
5	Working sheet AB-820 500 pneumatic connections	2 pages
6	Declaration of conformity	1 page
7	Approval certificate TÜV Nord	7 pages
8	Technical report TÜV Süd	4 pages
9	Warranty	1 page

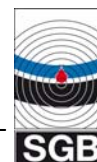

<u>Contents</u>	Page
1 Subject	2
2 Field of application	2
2.1 Requirements for interstitial spaces	2
2.2 Pipes	2
2.3 Materials carried in the pipes / leak detection medium	2
3 Description of functions and operation	3
3.1 Switching values and pressure values	3
3.2 Normal operation	3
3.3 Functions in the event of a leak	4
3.4 Air drying / dry filter	4
3.5 Description of the display and control elements	4
4 Installation and assembly instructions	5
4.1 General notes	5
4.2 Personal safety equipment	5
4.3 Installation of the leak detector	6
4.4 Installation of the connecting lines (leak detector -> interstitial space)	6
4.5 Installation of the dry filter	7
4.6 Electrical connections	7
4.7 Example installation	7
5 Commissioning / repairs	7
6 Operating instructions	8
6.1 General notes	8
6.2 Maintenance	8
6.3 Intended use	9
6.4 Functional tests	9
6.5 Alarm / fault	12
7 Disassembly	12
8 Marking	12
9 Abbreviations	12
 DIAGRAMS:	
Location of the test cocks	P – 078 000
Drawing for the ignition hazard analysis	Z – 078 920R
Installation example 1	M1 – 078 920R
Installation example 2	M2 – 078 920R
Current flow diagram	SL – 853 620
Test device	P – 115 395
 APPENDIX:	
TD Technical data	TD – 1
TF Dry filters	TF – 1
DP Evaluating the display for the function “tightness test”	DP – 1
S Statement on the cross-sections of the connecting lines between leak detector DLR-P and the interstitial spaces	S – 1

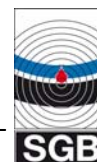

1. Subject

Overpressure leak detector for double walled plastic pipes with air used as the leak detection medium.

DLR-P../CV The dots are used in place of the alarm pressure. The alarm pressure may also be followed by additional letters to describe the design variant of the leak detector in more detail.

2. Field of application

2.1. Requirements for interstitial spaces

- Verified pressure resistance of the interstitial spaces (see section 3.1)
- Verification of suitability of the interstitial space (for Germany: certification of usability from building inspectorate).
- Tightness of the interstitial space (see section 6.4.7)
- The number of interstitial spaces to be monitored depends on the overall volume of the interstitial space. According to EN 13160, this must not exceed 10m³. In order to make it possible to verify the tightness of the interstitial space, we recommend that a value of 4 m³ is not exceeded.

The length of pipe which is to be monitored (per pipe branch) should not exceed 2500 m, and it should comply with the approval requirements of the pipe.

2.2. Pipes

Underground double walled pipes made of plastic, used as fill-, suction, or vapour recovery line having a sufficient pressure resistant interstitial space.

For Germany: More far reaching requirements for double walled pipes may result from TRBS, the DIBt approval principles or EN 13160.

2.3. Products conveyed in the pipes / leak detection medium

- Liquids which are hazardous to waters with a flash point > 55°C
- Water-polluting liquids with a flame point < 55°C
For pipes which are permanently filled with liquid you must make sure that the product-carrying equipment (delivery pumps ...) are suitable for Zone 0 because in case of a leak air is forced into the product.
- The product being conveyed must not react with the leak detection medium.
- The resistance of the pipes to the material being conveyed must be verified by third parties (e.g. operator, manufacturer of the pipe ...).

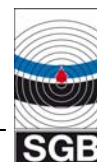

3. Description of functions and operation

The overpressure leak detector DLR-P../CV monitors both walls of a pipe for leaks. The monitoring pressure is high enough to ensure that leaks in the inner or outer wall are indicated through a pressure loss.

In order to build up the pressure, air is sucked in from the outside by the integrated pump via a dry filter and then pumped to the interstitial space(s).

The dry filter dries the outside air to a relative humidity of approximately 10%. The drying process is necessary in order to eliminate any accumulation of moisture or condensation in the interstitial space. **Used dry filter cartridges should be regenerated or replaced.**

3.1. Switching values and pressure values in bar

Type DLR-P	p_{DP} [bar]	p_{AE_ON} [bar]	p_{PA_OFF} [bar]	p_{TEST} [bar]
1.1	< 0.1	> 1.1	< 1.45	≥ 5.0
1.5	< 0.5	> 1.5	< 1.9	≥ 5.0
2.0	< 1.0	> 2.0	< 2.4	≥ 5.0
–	Special values agreed between SGB and the customer.			

p_{DP} Max. delivery pressure in the inner pipe

p_{AE} "Alarm ON" switching value – an alarm is triggered at the latest when this value is reached.

p_{AA} "Alarm OFF" switching value – the alarm is cancelled when this value is exceeded. The switching value "Alarm OFF" is approximately 100 mbar higher than the switching value "Alarm ON" ($p_{AA} = p_{AE} + \sim 100$ mbar)

p_{PA} "Pump OFF" switching value (=setpoint pressure)

p_{PE} "Pump ON" switching value

The switching value "Pump ON" is around 100 mbar lower than the switching value "Pump OFF" ($p_{PE} = p_{PA} - \sim 100$ mbar)

$p_{ÜDV1}$ p_{TEST} Minimum test pressure of the interstitial space

3.2. Additional explanations on explosion protection (see also Z-078 920R)

This leak detector is for use in double-walled plastic pipes with which there is a possibility of permeation into the monitoring chamber, i.e. Zone 0 conditions are possible.

Based on this approach, other additional measures must be implemented:

- Suitable flame arresters (engineered for overpressure) at each inlet to the monitoring chamber
- Check valve in the connection line to prevent possible potentially explosive vapour and air mixtures from flowing back. The check valve (CV) is installed below the leak indicator below the pulsation damper.
- An overpressure valve cannot be used. Therefore the test pressure of the monitoring chamber must be significantly higher than the operating pressure of the leak detector.

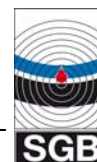

3.3. Normal operation

The leak detector is connected via the connecting line(s) to the interstitial space(s). The overpressure generated by the pump is measured via a pressure sensor and regulated.

When the operating pressure (Pump OFF) is reached the pump is switched off. Due to leaks in the leak detection system which are unavoidable, the pressure will start to slowly rise again. When the switching pressure "Pump ON" is reached the pump is switched on and the system builds operating pressure back up again.

During normal operation, the leak detector fluctuates between these two pressure values, with short run-up times and longer standstill times which depend on the tightness and temperature fluctuations of the overall plant.

3.4. Functions in the event of a leak

If a leak occurs on the inside wall or the outside wall then air will escape from the interstitial space. The pressure will drop until the pump is switched on in order to restore operating pressure. If the volumetric flow escaping through the leak is greater than the (limited) delivery rate of the pump then the pressure in the system drops and the pump runs in continuous operation.

Any increase in the size of the leak leads to a further pressure loss until eventually the alarm pressure is reached. At this point the system will generate visual, audible and potential-free alarm outputs.

3.5. Air drying / dry filter

The air supplied to the interstitial space is passed through a dry filter in the intake line. The dry filter dries the air to a relative humidity of around 10% in order to prevent corrosion and accumulation of condensation in the interstitial space.

The dry filter is designed to last for a year provided the equipment is used for its proper intended use and no additional temperature fluctuations occur.

Initially the dry filter is an orange colour, but this fades to a colourless (or green) state when the filter has been used up. Once the filter cartridge has been used up it should be replaced or regenerated.

3.6. Description of the display and control elements

3.6.1 Display element states (signal lamps) for type DL ..

Signal lamp	Operating status	Alarm status	Alarm, audible alarm signal acknowledged	Device fault
OPERATION: green	ON	ON	ON	ON
ALARM: red	OFF	ON	FLASHING	ON

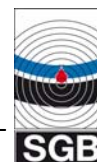

3.6.2. Operating functions via pushbuttons

Switching off the acoustic alarm signal:

Briefly press the "Audible alarm" button once – the audible alarm signal is then switched off and the LED flashes.

Pressing the button again will cause the audible signal to be switched on.

(This function is not available in normal operation or during malfunctions.)

Testing the visual and audible alarm signal

Press the "Audible alarm" button and keep it pressed (approx. 10 seconds) – the alarm signals are triggered until the button is released again.

This test is only possible if the pressure in the system has exceeded the "Alarm OFF" pressure level.

Testing the tightness of the monitored system

Press the "Audible alarm signal" button and keep it pressed until the "Alarm" signal lamp flashes at high speed, then release the button. A value for the tightness is indicated through illumination of the "Alarm" signal lamp. (see Appendix DP)

For this test the leak detector must have performed at least 1 automatic feed interval in normal operation (i.e. without being filled by an assembly pump) in order to obtain a valid result.

4. Installation and assembly instructions

4.1. General notes

- (1) Installation and assembly must only be performed by qualified companies¹.
- (2) The relevant accident prevention regulations of the *Wasserhaushaltsgesetz* (Water Resources Act, WHG) must be complied with.
- (3) Explosion protection requirements must be satisfied (where necessary), such as laws on the basis of the European Directive 1999/92/EG and/or other applicable codes.
- (4) A test valve shall be provided at the leak detector opposite end of the pipe(s).
- (5) Before accessing control shafts, measure the vapour-air mixture and the O₂-level.
- (6) When using metallic connection lines, you must make sure that the mains earth is connected to the same potential as the tank/pipe being monitored.

4.2. Personal safety equipment

The parts listed here apply in particular to safety when working on plants which may pose an potentially risk of explosion.

If work is carried out in industries in which it must be assumed that an explosive atmosphere is present then the following items of equipment are required as an absolute minimum:

- Suitable clothing (risk of a build-up of electrostatic charge)
- Suitable tools (compliant with EN 1127)

¹ In Germany: Companies who have the status of a "qualified company" in the sense of §19I of the *Wasserhaushaltsgesetz* (Water Resources Act, WHG) 19I, who are qualified to carry out installations of leak detection systems and can demonstrate proof of expertise and knowledge in relation to fire safety and explosion protection.



- A suitable gas warning device which is calibrated for the existing vapour-air mixture (work should only be performed at a concentration of 50% below the lower explosion limit)²
- Measuring device for determining the oxygen content of the air (Ex / O meter)

4.3. Installation of the leak detector

- (1) Generally in a wall-mounted installation with wall plugs and screws.
- (2) In a dry room, or out in the open in a suitable housing.
- (3) **NOT in areas with a potentially risk of explosion.**
- (4) The distance between the leak detector and the interstitial space should be kept as short as possible (refer also to the next section).
- (5) If more than one double-walled pipes are connected to one leak detector, a shut-off device must be provided for each section.

4.4. Installation of the connecting lines (leak detector -> interstitial space)

- (1) Metal (generally Cu) or plastic pipes with a compressive strength of at least 5 bar. Also applies to fittings and screw connections. (Adhere to the temperature range, in particular when using plastics).
- (2) Establish the connection to the monitoring chamber using a suitable detonation safety barrier (up to 3 bar operating overpressure).
- (3) Clear width at least 6 mm.
- (4) 50 m should not be significantly exceeded – but if so: use a tube with a greater clear width with corresponding bridging pieces. In the process you must make sure that the detonation safety barrier is suitable (area of application).
- (5) The full cross-section must be retained. Pinching and kinking³ are not permitted.
- (6) Metal or plastic tubes underground, or plastic tubes routed overground should be routed inside a conduit.
- (7) The conduit should be sealed gas-tight.
- (8) The pressure and measuring lines can be combined together underneath the leak detector via pulsation damper 107 (see installation examples).
- (9) Avoid any build-up of electrostatic charge (e.g. when drawing in lines).
- (10) For details of the connection technology to be used refer to Work Sheet AB-820 500 (see Information).
- (11) All conductive parts must be connected to each other by a conductive connection. The bleeder resistance must be $\leq 10^6 \Omega$.

² Other %-specifications may result from works-specific or German *Land*-specific regulations.

³ If required, commercially available shaped sections should be used for plastic tubes (pre-defined bending radii)

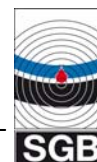

4.5. Installation of the dry filter

- (1) Preferably close to the leak detector.
- (2) Vertical with the intake opening facing down, using the enclosed installation materials.
- (3) The dry filter and in the intake connection port of the leak detector should be connected via a PVC hose (or similar).
- (4) The dry filter must be installed so that it is impossible for potentially explosive vapour and air mixtures to be suctioned.

4.6. Electrical connections

- (1) Power supply: in accordance with the imprint on the type plate.
- (2) Hard wired, i.e. no plug-in or switchable connections.
- (3) The regulations of the electricity supply companies must be satisfied⁴.
- (4) Terminal assignment: (see also SL-853 600)
 - 1 / 2 Mains connection
 - 3 / 4 Assigned (to the internal pump)
 - 5 / 6 External signal (in the event of an alarm, mains voltage is present here - it is switched off by pressing the "Audible alarm" button).
 - 11 / 12 Potential-free contacts (open in the event of an alarm and in the event of a power loss)

4.7. Example installation

Example installations are shown in the Appendix.

5. Commissioning / repairs

- (1) Note the requirements in section 4.
- (2) If a leak detector is taken into operation on a pipe which is already in operation, then special protection measures need to be put in place (e.g. flushing with subsequent check to make sure there is no gas in the leak detector and monitoring chamber). Further measures may depend upon the local conditions and should be assessed by qualified personnel.
- (3) Once the pneumatic connections have been made, make the electrical connections.
- (4) Check that the signal lamps for "Operation" and "Alarm" light up and that the audible alarm signal sounds, if necessary switch off the alarm.
- (5) Connect the three-way cock 21 in the position "III", connect a gauge. (Drawing: P-078 000)
- (6) The leak detection system should be supplied with the operating pressure according to the table on page 3. (Use of an assembly pump, with sufficiently dimensioned dry filter or a nitrogen pressure cylinder).

⁴ In Germany: compliance is also required with the VDE regulations.

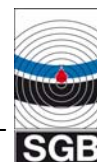

- (7) Build-up of pressure with the assembly pump or the pressure cylinder (observe the pressure settings) - can be performed directly via the pressure line or via the three-way cock 20 (position IV).

Note: If no pressure is built up with the assembly pump (or pressure gas canister) connected, then the leak should be located and rectified (if required check that the delivery rate of the assembly pump and the settings of the pressure reducer are correct).

- (8) Once the operating pressure of the leak detector has been reached (pressure generation inside the leak detector switches off), reconnect the high-pressure line and/or set both cocks to "I", remove the pressure measuring instrument.
- (9) Functional test according to section 6.4.1.

6. Operating instructions

6.1. General notes

- (1) It can be assumed that the system will work correctly without any problems if the leak detection system is installed correctly without leaks.
- (2) If the pump comes on frequently or runs continuously then this indicates that leaks are present which will require attention within due course.
- (3) If an alarm is triggered locate and rectify the cause quickly.
- (4) Explosion protection requirements must be satisfied (where necessary), such as laws on the basis of the European Directive 1999/92/EG and/or other applicable codes.
- (5) The "Operation" signal lamp extinguishes to indicate any breaks in the current supply. The alarm signal has to be forwarded by the floating relay contacts.

The forwarding is necessary so that a power failure is noticed and a reaction is made. Vapours from the monitoring chamber must be reliably prevented from entering back into the leak detector.

After the interruption in the current supply, the green signal lamp comes back on and the alarm signal which is output via the potential-free contacts is cancelled (unless the pressure has dropped below the alarm pressure while the current supply was interrupted.)

- (6) The filter cartridge should be replaced or regenerated when it changes colour from orange to having no colour (or green, depending on the type of drying material).

6.2. Maintenance

6.2.1 Performed by the operator

- (1) The dry filter should be checked at regular intervals⁵. The filter cartridge should be replaced or regenerated when it changes colour from orange to having no colour (or green).

⁵ A gap of at least 2 months is recommended.

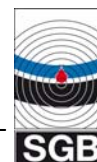

6.2.2 Maintenance work and functional tests performed by qualified persons⁶.

- (1) Testing once a year for functional and operational reliability and safety.
- (2) Test scope according to section 6.4.
- (3) It should also be checked that the conditions in sections 4, 5 and 6.2 are satisfied.

6.3. Intended use

- For underground double walled pipes made of plastics.
- Pipe is depressurised in the inner pipe (=filling, suction or ventilation line)
- Vapour-air mixtures which may potentially arise due to
 - the liquid being conveyed,
 - the liquid being conveyed in conjunction with air/air moisture or condensate
 - the liquid being conveyed in conjunction with the materials usedmust be classifiable in temperature classes T1 to T3 and in explosion group II A
- The feed pressure (in the inner pipe) must be at least 1 bar lower than the minimum alarm pressure.
- It is impossible for potentially explosive vapour and air mixtures to be suctioned through the dry filter.
- The system must be earthed in accordance with applicable regulations⁷
- Tightness of the leak detection system should be ensured according to section 6.4.7.
- The leak detection unit must be installed outside the potentially explosive-area.
- Conduits for connecting lines must be sealed gas-tight.
- The leak detector should be (electrically) connected in a way which cannot be switched off.
- The maximum temperature increase during filling is 40°C.
- The room in which the leak detector is installed is sufficiently ventilated.
- The annual functional check as per this documentation must be carried out, including adherence to the stipulated order.

6.4. Functional tests – the following order must be strictly adhered to

Testing of the functional and operational safety and reliability should be performed

- at every commissioning
- in accordance with the intervals laid out in section 6.2⁸
- whenever a fault is rectified.

⁶ In Germany: by a trained specialist with expertise in the maintenance and servicing of leak detection devices, or under the responsibility of a trained and qualified individual in accordance with the applicable regulations.

⁷ In Germany e.g. EN 1127, regulations of EVU's

⁸ In Germany: legal regulations of the *Länder* also need to be satisfied (e.g. VAWS).

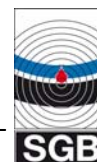

6.4.1 Test scope

- (1) If necessary the work to be performed should be discussed with the person who is responsible on-site.
- (2) Observe the safety information on handling the products being conveyed.
- (3) Replacement or regeneration of the filter cartridge.
- (4) Check the test valve at the end of the interstitial space away from the leak detector for tightness and check that it is free of dirt – clean as required.
- (5) Test for free passage of air through the interstitial space for every duct (section 6.4.2)
- (6) Testing the tightness of the check valve (section 6.4.3)
- (7) Test the switching values with a testing device (section 6.4.4).
- (8) Tightness test (section 6.4.5)
- (9) Set up the equipment ready for operation (section 6.4.6)
- (10) Completion of a test report by the qualified person, with confirmation of functional and operational safety and reliability.
- (11) Before starting work, we recommend performing the leak test of the system (which is integrated in the leak detector) as described in section 3.5.2, in order to gain an impression of the condition of the system.

6.4.2 Test for free passage of air through the interstitial space (see P-078 000)

- (1) If several interstitial spaces are connected then each interstitial space should be tested individually for free passage.
- (2) If several interstitial spaces are connected via a manifold with a shut-off device then all of the shut-off valves of the manifold should be closed.
- (3) Connect a gauge to the three-way cock 21 and set it to position "III". (The operating pressure is displayed as the pressure and measuring lines are connected together.)
- (4) Open all shut-off valves at the ends of the pipe and leave them in the open position.
- (5) Open the shut-off device in the distribution of the monitoring chamber being tested. The pressure on the testing and measuring instrument will drop.
IMPORTANT NOTE: Maintenance work and functional tests must only be performed by qualified persons.
- (6) Close the shut-off device in the distribution which was opened previously. The leak detector will build up operating pressure.
- (7) Repeat steps (5) and (6) for every other pipe.
- (8) Close the test valves opened in (4) and wait for the pressure to build up.
- (9) Set the three-way cock 21 to position "I" and disconnect the gauge.
- (10) Open all shut-off valves on the manifold with the pipe connected.

6.4.3 Testing the check valve for untightness

- (1) Three-way valve 20 to position "II", the overpressure pump delivers into the open air.
- (2) Three-way valve 21 to position "III", wait for pressure drop to atmospheric pressure and then connect the measuring instrument to the nozzle.

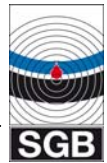

- (3) The pressure must not increase by more than 1 mbar within one minute. If it does, the check valve will need to be replaced.
- (4) Switch three-way valves 20 and 21 to position "I" and remove the testing and measuring instrument.

6.4.4 Test the switching values with a testing device (see P-115 395)

- (1) Connect a testing device to the free connection port on the three-way cocks 20 and 21 (insert hose clips). Set both cocks to position "II".
- (2) Connect the gauge to the test device.
- (3) Close the needle valve (testing device) – pressure is then built up on top of the operating pressure.
- (4) Vent via the needle valve, determine the switching values for "Pump ON" and "Alarm ON" (visual and audible), write the values down.
- (5) Close the needle valve and determine the switching values for "Alarm OFF" and "Pump OFF", write the values down. (If necessary open the needle valve slightly so that there is a slow pressure increase.)
- (6) Set the three-way cocks 20 and 21 to position "I". Disconnect the testing device.

6.4.5 Tightness test (see P-078 000)

- (1) Check that all shut-off valves with connected interstitial space are opened.
- (2) Connect a gauge to the three-way cock 21 and set it to position "III".
- (3) Start with the tightness test once the pressure has been equalised. The test is passed if the values in the table below are met. A greater drop in pressure means more stress on wearing parts.

Interstitial space volume (litres)	Max. pressure drop of 1 mbar (0.015 psi) after
250	22 minutes
500	45 minutes
1000	1.50 hours
1500	2.25 hours
2000	3.00 hours
2500	3.75 hours
3000	4.50 hours
3500	5.25 hours
4000	6.00 hours

- (4) Set the three-way cock 21 to position "I" and disconnect the gauge.

6.4.6 Set up the equipment ready for operation

- (1) Seal the housing.
- (2) The shut-off valves for all connected pipes must be set to their open position.



6.5. Alarm / fault

- (1) The red signal lamp comes on and an audible signal sounds.
- (2) Press the "Audible alarm" button to silence the audible signal.
- (3) Contact the installation company immediately.
- (4) Determine and rectify the cause for the alarm, then perform a functional test of the leak detection system as described in section 6.4.

7. Disassembly

The following points are particularly important for the disassembly of plants and systems which could represent explosive hazards.

- Applicable regulations for the disassembly of electrical systems must be followed.
- Check that no gas (potentially explosive atmosphere) is present before and during the work.
- Seal any openings gas-tight that could otherwise allow the spread of an explosive atmosphere.
- Do not use electrical equipment capable of generating sparks (saw, cutting grinder...) for disassembly. If this is unavoidable, follow the instructions in EN 1127.
- Use low-sparking tools.
- Avoid any build-up of electrostatic charge (e.g. due to friction).
- Contaminated components (potential outgassing) should be disposed of appropriately.

8. Marking

- Electrical data
- Serial no.
- Type designation
- Date of manufacture (month / year)
- Manufacturer's code
- Legally required symbols/marks
- The connecting line(s) can be connected to areas for which category 3 devices (Group II (G)) are required (T1 to T3; IIA to IIB).

9. Abbreviations

- | | |
|------|--|
| 01 | Signal lamp – "Alarm" – red |
| 02 | Shut-off valve |
| 09 | Signal lamp - "Operation" - green |
| 17 | Overpressure pump |
| 20 | Three-way cock in the high-pressure line |
| 21 | Three-way cock in the measurement line |
| 24.1 | Fuse |



22	Venting device
30	Housing
44	Solenoid valve
52	Gauge
57	Test valve
59	Relay
61	Check Valve
69	Buzzer
70	Overpressure valve
71	“Audible alarm” button
72	Dry filter
74	Connecting line
76	Main circuit board
84	Test container, 1-litre
85	Test connection port (gauge)
88	Double walled pipe / double walled fitting or combination of the two
99	Control shaft
102	Pressure sensor
105	Control unit
106	Contacts for serial data transfer
107	Pulsation damper

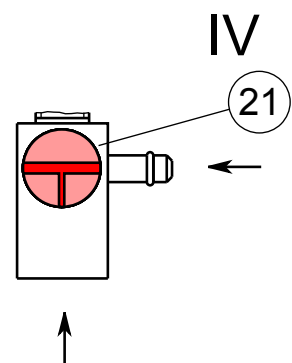
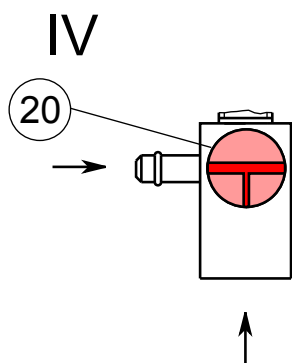
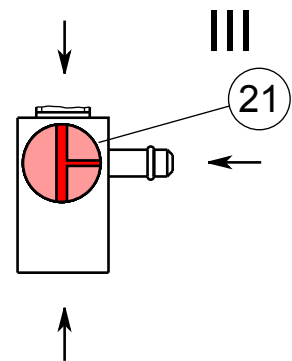
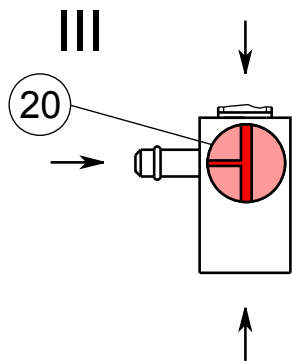
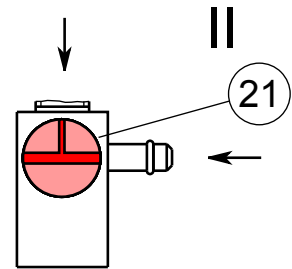
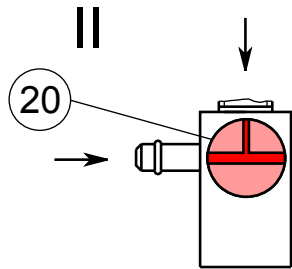
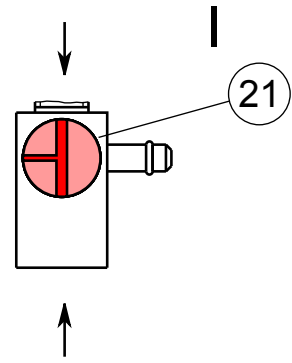
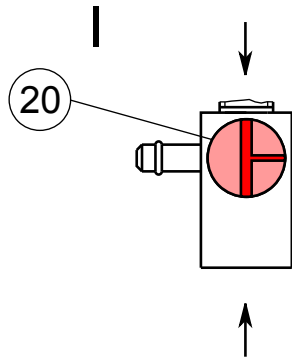

Pressure line

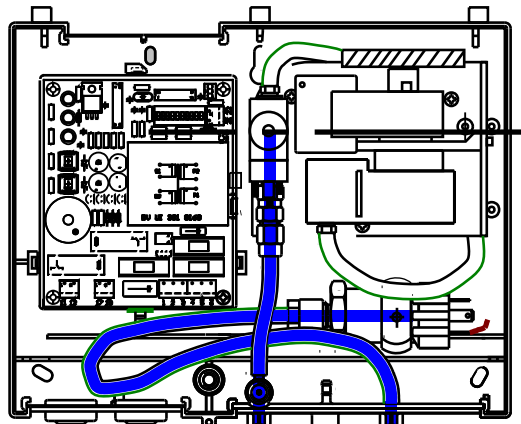

Measuring line

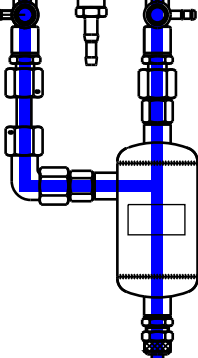

Solenoid Valve as a Zone Separator

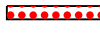

Check Valve as a Zone Separator

-  Zone 2
-  Zone 1
-  Zone 0

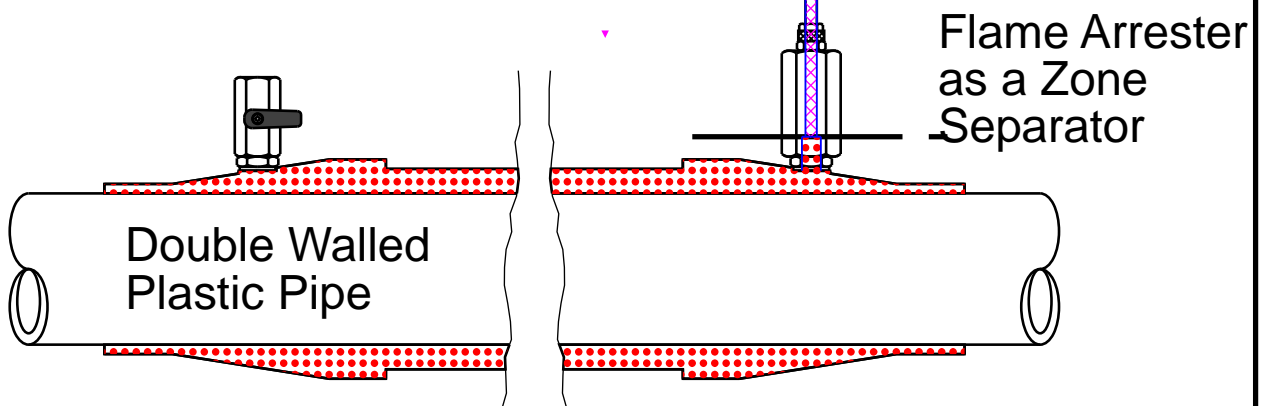
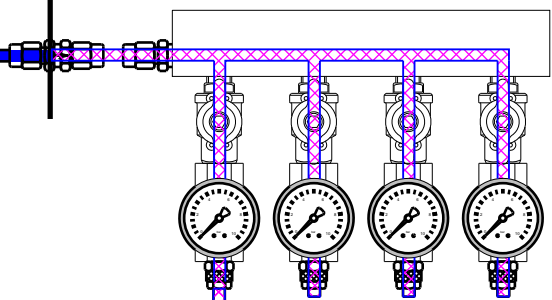

Flame Arrester as a Zone Separator

Double Walled Plastic Pipe

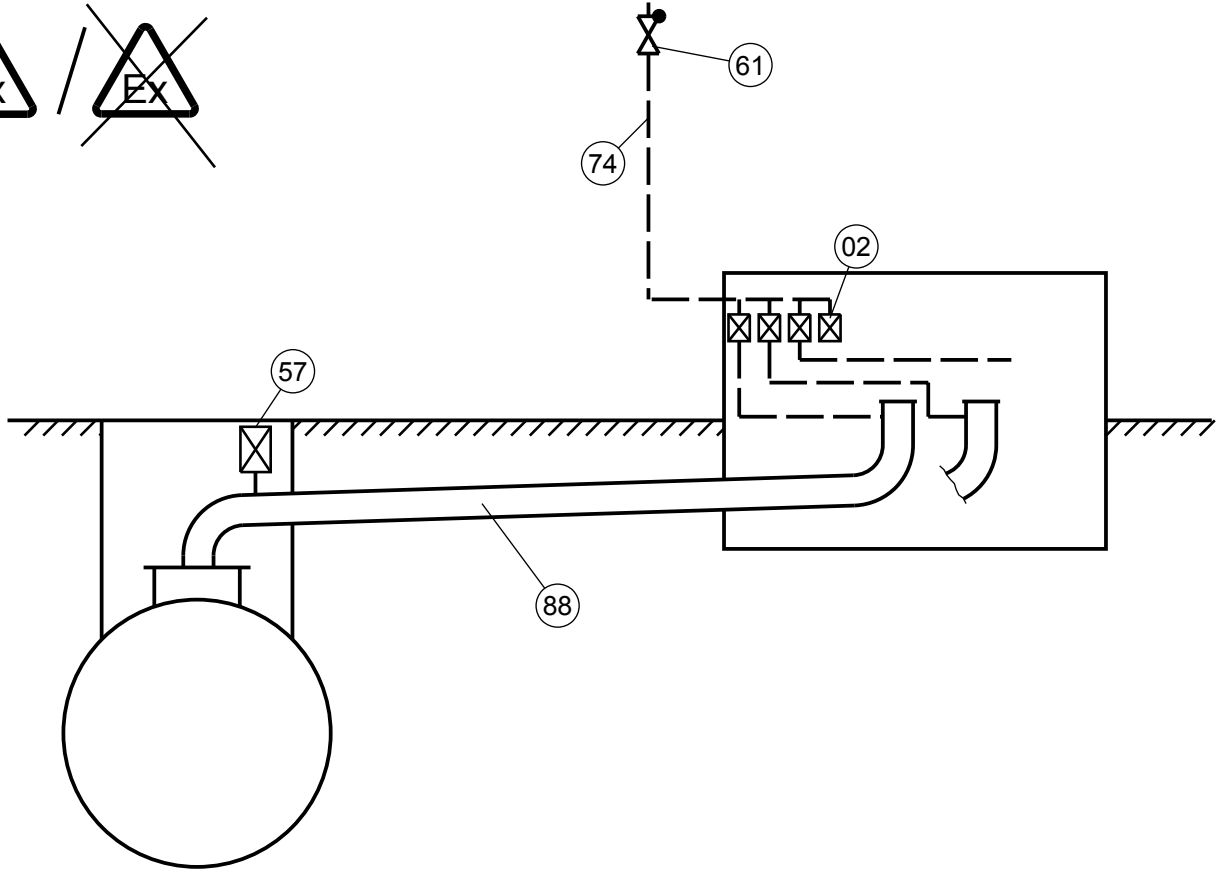
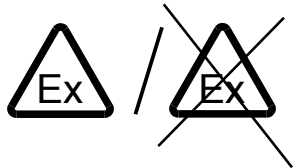
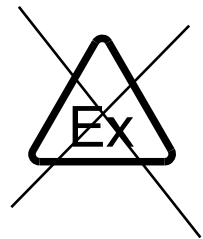
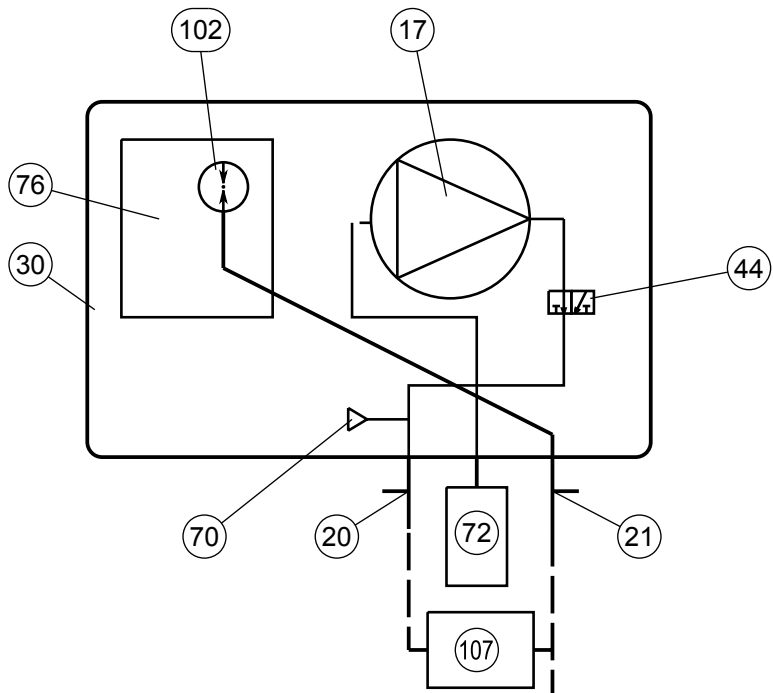

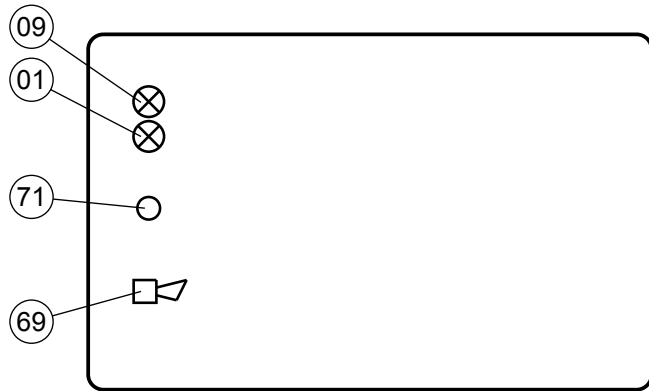

230 V / 50 Hz

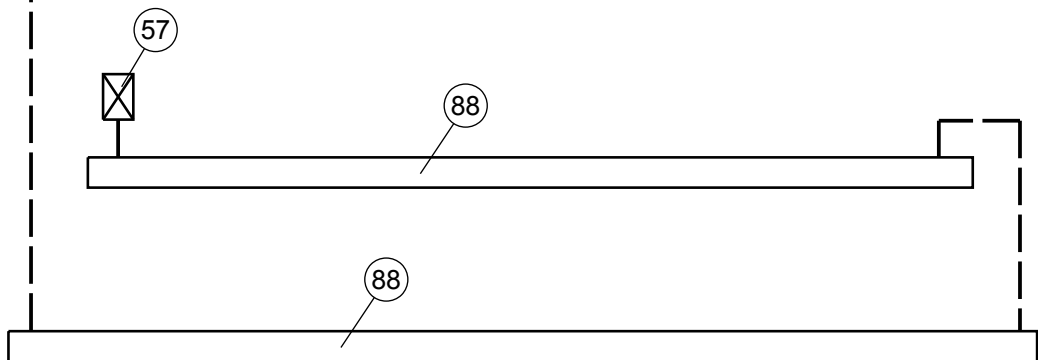
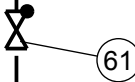
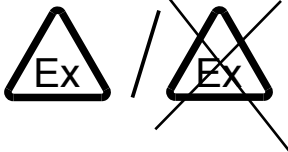
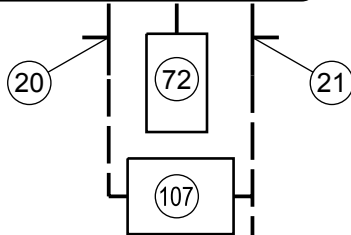

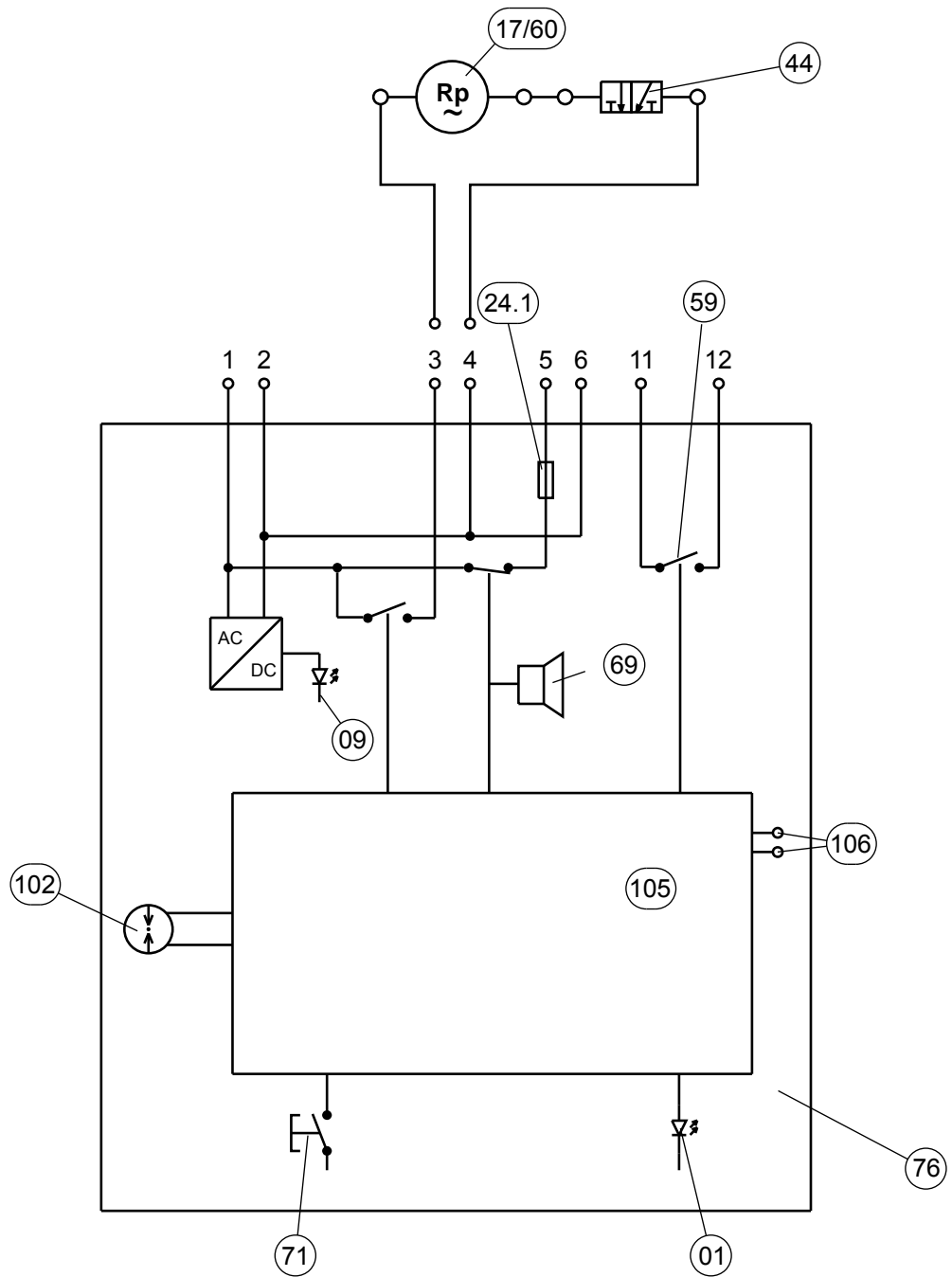

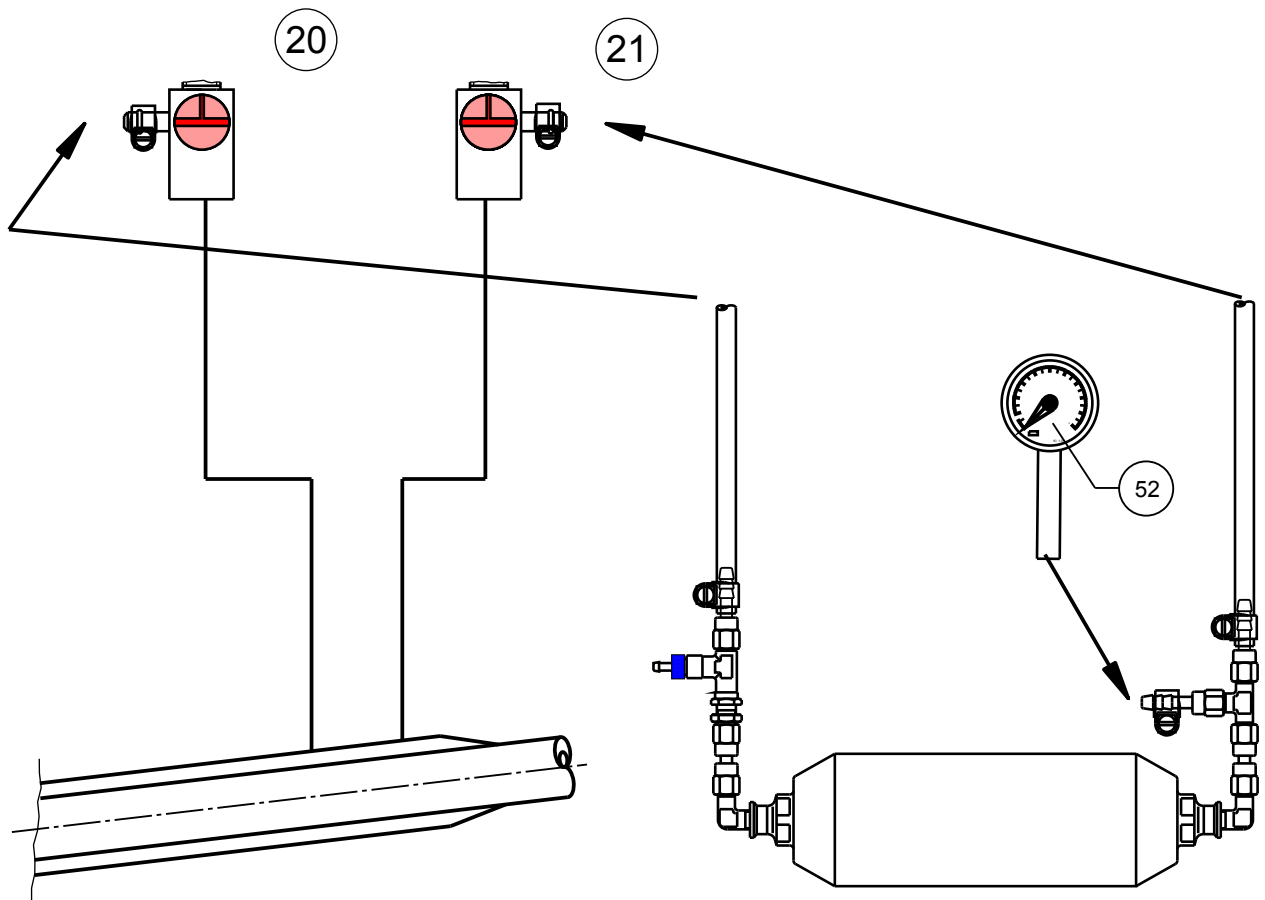
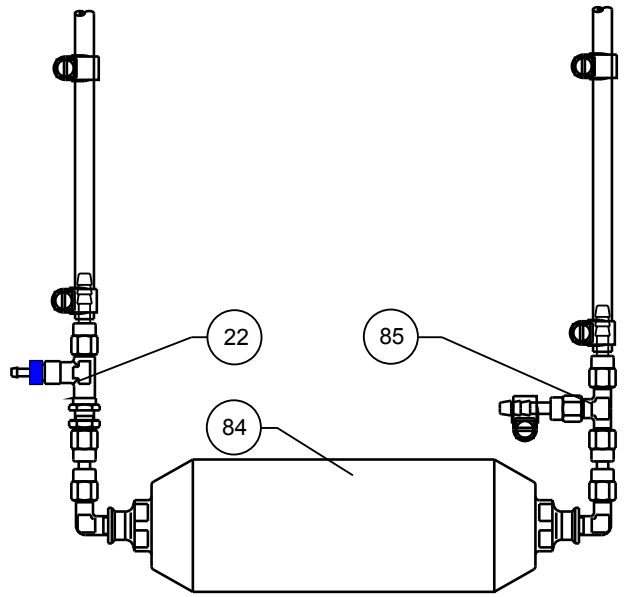
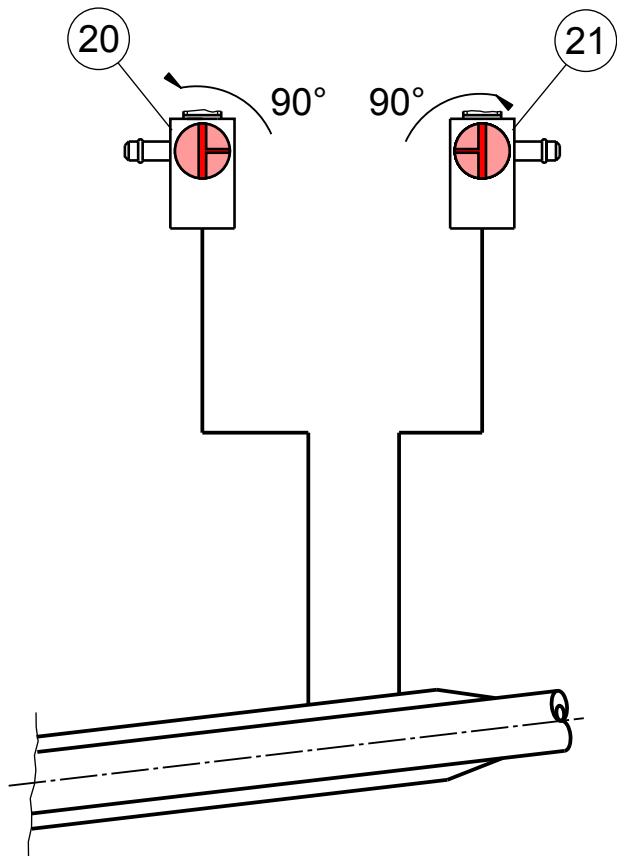



Technical data

1. Electrical data

Rated input (without external signal)	230~ V - 50 Hz - 150 W
Switching contact load, terminals AS (5 and 6)	230~ V - 50 Hz - 200 VA
Switching contact load, potential-free contacts (terminals 11 and 12)	max: 230~ V - 50 Hz - 3 A min: 6 V / 10 mA
External fuse for the leak detector	max. 10 A
Overvoltage category	2

2. Pneumatic data (requirements for the test measuring instrument)

Rated size	min. 100
Accuracy rating	min. 1.6
Scale end value	appropriate according to the operating pressure



Dry filters

1 Dry filters for underground pipes:

TF 200 (the larger dry filters could however also be used)

2 Dry filters for overground pipes:

Type	Max. volume of the interstitial space with			
	TF 200	TF 400	TF 600	TF 1200
DLR-P 1.1	400	750	1150	2600
DLR-P 1.5	300	650	800	1850
DLR-P 2.0				



Evaluating the display for the function "Tightness test"

Chapter 3.6.2 described "Checking the tightness of the monitored system". This function can be used to obtain an indication of the tightness of the monitored system.

This is only possible if the switching value "Alarm OFF" has been exceeded. It can be repeated several times in succession.

This check is advisable **before** carrying out a recurrent function test on a leak detector, to see directly whether there is any need to look for leaks.

After pressing the button, this is confirmed by a brief audible signal which can be heard once, followed by a flashing signal, i.e. the Alarm LED flashes briefly to indicate the tightness as follows:

Number of flashes	Evaluation of the tightness
0	Very tight
1 to 3	Tight
4 to 6	Sufficient tight
7 to 8	Maintenance recommended
9 to 10	Maintenance highly recommended

The smaller the above value, the more tight is the system. The meaningfulness of this value naturally also depends on temperature fluctuations and should therefore be considered to be an indicative value.



Statement on the cross-sections of the connecting lines between leak detector DLR-P and the interstitial spaces

In the past, the connecting lines between the interstitial spaces and the leak detector have been routed in accordance with TRbF 501 and 502 with the following dimensions:

- for underground or frost-proof routing: clear width of at least 4 mm,
- for overground routing or routing at risk of frost: clear width of at least 6 mm.

In future, the European standard for leak detection systems EN 13160 will require

- connecting lines carrying air to be routed with a clear width of at least 6 mm, and
- connecting lines carrying nitrogen to be routed with a clear width of at least 4 mm.

This requirement in relation to the routing of connecting lines will have take effect immediately and continue into the future.

It already has an impact in terms of the approval of leak detectors. This is why a minimum diameter of 6 mm for the connecting line is required in the approval for the leak detector DLR-P.. .

Installation of the connecting line with a clear width of 4 mm in accordance with TRbF is technically accepted and therefore not something which should be questioned at present. From a technical point of view, there are no objections to using a DLR-P leak detector on pipes with 4 mm frost-free connecting lines which are routed underground or inside between interstitial spaces and the leak detector.

Siegen, 25.05.2004

J. Berg
-Executive Board-

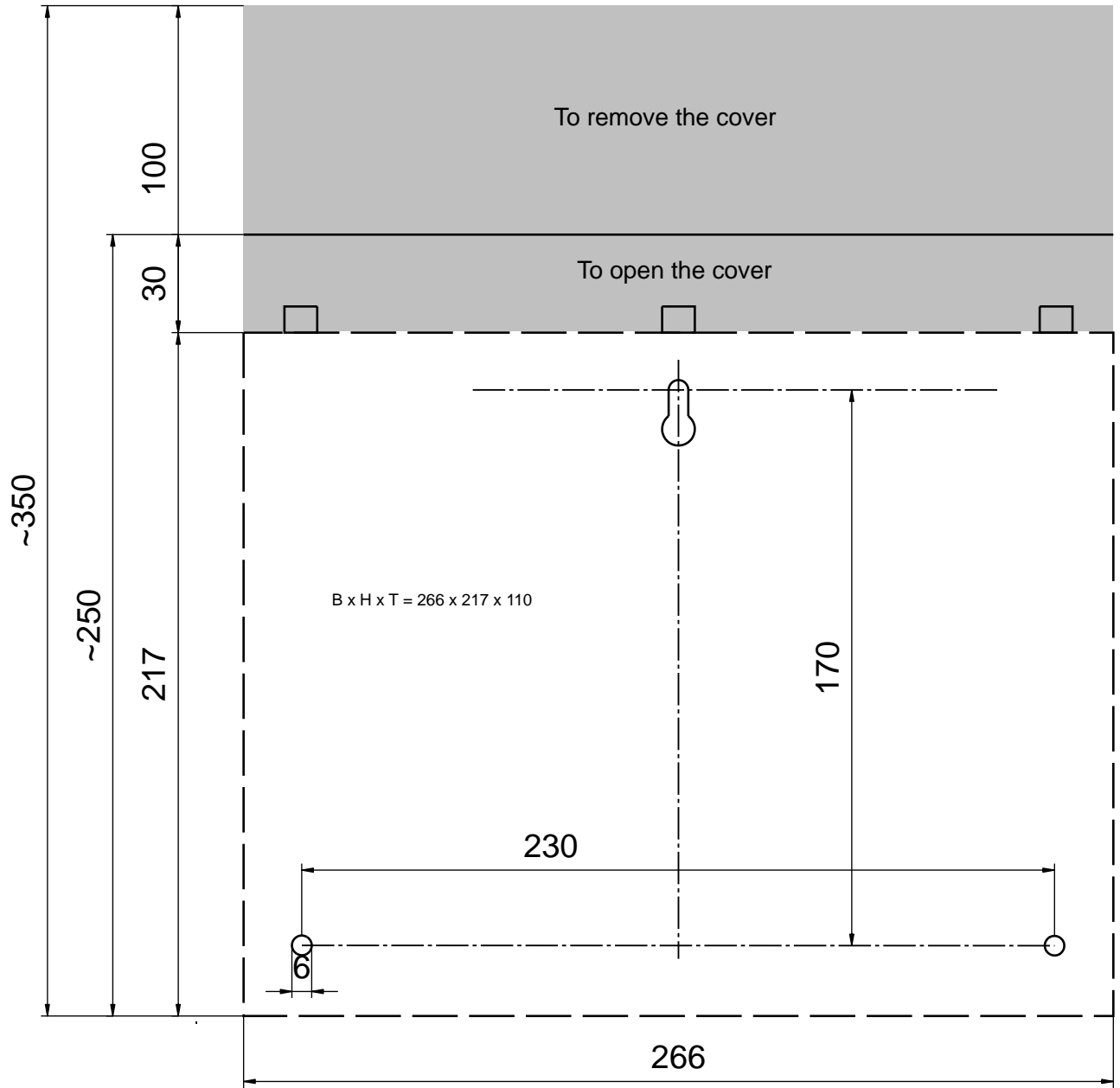

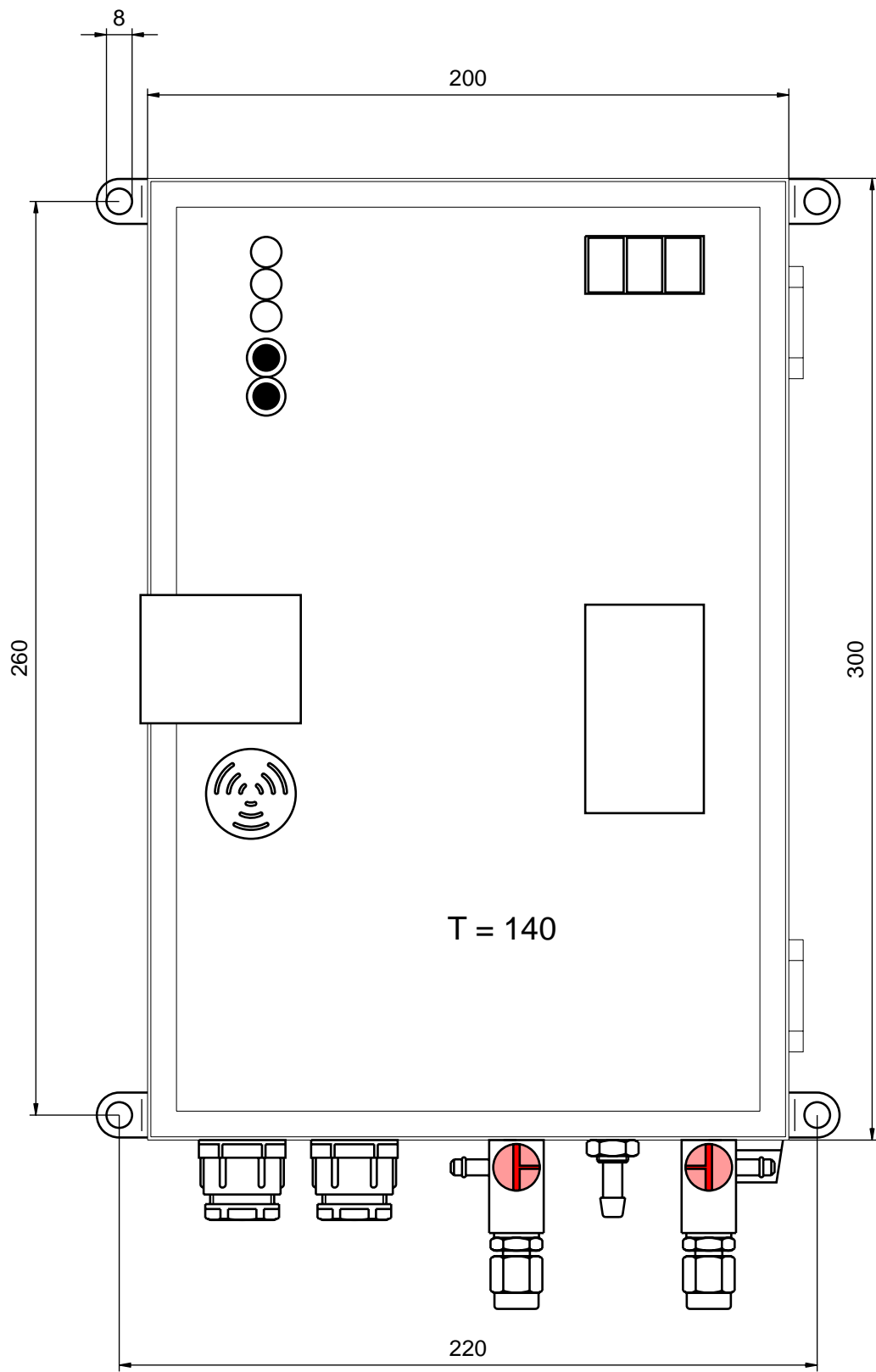

Installation of screw connections

1 Flanged screw connection for flanged pipes

1. Oil O-rings
2. Place the intermediate ring loosely in the screw connection sleeve
3. Push the union nut and pressure ring over the pipe
4. Tighten the union nut by hand
5. Tighten the union nut until there is a noticeable increase in force
6. Final installation: Turn $\frac{1}{4}$ turn further



2 Clamping ring screw connection for plastic and metal pipes

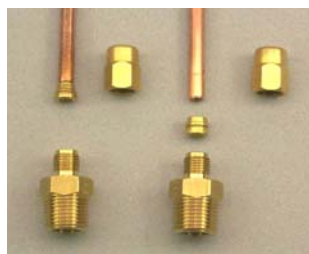

1. Insert support sleeve into the pipe end
2. Insert the pipe with support sleeve as far as it will go
3. Tighten the screw connection until stronger resistance can be felt
4. Unfasten the nut slightly
5. Tighten the nut until there is noticeable resistance (The nut must match the thread on the base body exactly)



3 Cutting ring screw connection for plastic and metal pipes



1. Insert the reinforcement sleeve into the end of the pipe
2. Drive in the reinforcement sleeve
3. Push the union nut and cutting ring over the end of the pipe
4. Screw the union nut on by hand until it noticeably rests in place
5. Press the pipe against its limit stop with internal cone
6. Tighten the union nut by approximately 1.5 turns (pipe must not turn)
7. Unfasten the union nut: check whether the pipe can be seen to protrude from the cutting ring. (not of significance if the clamping ring can be turned)
8. Tighten the union nut without applying increased force.

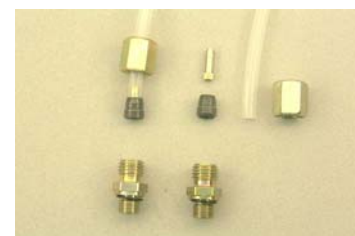

Installation of screw connections

4 Quick-release screw connection for PA and PUR hose

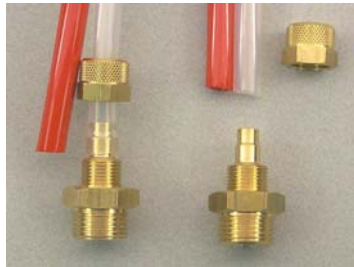

1. Cut the PA pipe to length at a right angle
2. Unfasten the union nut and push it over the end of the pipe
3. Push the pipe onto the nipple up to the start of the thread
4. Tighten the union nut by hand
5. Re-tighten the union nut with a screwdriver until there is a noticeable increase in force (approximately 1 to 2 turns)

NOT suitable for PE hose

5 Hose connections (4 and 6 mm nozzle for OVERPRESSURE)



1. Push the wire or screw clip over the hose
2. Push the hose onto the Cu pipe or hose nozzle (heat or moisten PVC hose as necessary). The hose must fit tightly all round
3. Wire clip: press together with pliers and push onto the connection point
Screw clip: push onto the connection point and tighten with screwdriver make sure that the clip is an even tight fit..

6 Hose connections (4 and 6 mm nozzle for NEGATIVE PRESSURE)

For negative pressure applications with which there is no overpressure on the connection lines even in case of a leak, as point 5 but without clips.

For negative pressure applications with which there may be overpressure, as point 5 but without clips.

EC DECLARATION OF CONFORMITY



We,

SGB GmbH
Hofstraße 10
57076 Siegen, Germany,

hereby declare in sole responsibility that the leakage probes

DLR-P../CV

comply with the essential requirements of the EC directives listed below.

This declaration shall lose its validity if the device is modified without consulting us.

Number / short title	Satisfied regulations
2004/108/EC EMC Directive	EN 61 000-6-3: 2007 + A1: 2011 EN 61 000-6-2: 2005 EN 61 000-3-2: 2014 EN 61 000-3-3: 2013
2006/95/EC Low Voltage Directive	EN 60 335-1: 2012 EN 61 010-1: 2010 EN 60 730-1: 2011
89/106/EEC Construction Products Directive 93/68/EEC	EN 13 160-1-2: Approved body: TÜV-Nord, Hamburg
94/9 EEC Equipment in Potentially Explosive Atmospheres	The leak detector with its pneumatic parts may be connected to spaces (interstitial spaces of tanks / pipelines / fittings) which are required for category 1 devices, under taking the requirements out of the relating documentation into consideration. The following documents were used: EN 1127-1: 2011 EN 13 160-1-2: 2003 EN 13463-1: 2009 The ignition hazard analysis of the TUEV-Sued The ignition hazard analysis did not result in any additional hazards.

Compliance is declared by

Martin Hücking
(Technical Director)

A p p r o v a l C e r t i f i c a t e

for the design of a leak detector as part of a leak indication device

Client:

SGB

Sicherungsgerätebau GmbH Hofstraße 10 57076 Siegen

Dipl.-Ing.

TÜV NORD GmbH.

Große Bahnstraße 31, 22525 Hamburg

9: 040/85572102

Az.:0111 BM 21610

Date: 01. February 2006

1 Subject

Overpressure leak detector as part of a leak detection system for connection to interstitial spaces of double walled pipes.

2 Manufacturer

SGB Sicherungsgerätebau GmbH
Hof Strasse 10 57076 Siegen

3 Information about the leak detector

3.1 Type

DLR-....

3.2 Area of use

Double walled pipes and double walled fittings, the interstitial spaces of which are sufficiently resistant to pressure and are verifiably suitable for connection of an overpressure leak detector.

3.3 Design

The overpressure leak detector DLR-... essentially comprises a pressure recorder and a leak detection device. Air or an inert gas can be used as the leak detection medium, whereby the conditions laid out in section 6.3 of the technical description must be complied with.

On this leak detector, controlling and signal processing are performed by an electronic circuit. The alarm switching pressure can be adjusted in 1 bar increments up to a maximum of 18 bar using the micro selector switch on the PCB. Special switching values which can be agreed with the manufacturer of the leak detector are also possible. The leak detector can be operated with both air and inert gas as the leak detection medium, with two possible operating modes:

Mode S - The necessary operating overpressure in the interstitial space is created through a process of pressure-controlled refilling from a stationary pressure accumulator which is connected to the interstitial space.

Mode M - The necessary operating overpressure in the interstitial space is provided by connecting a mobile pressure accumulator before starting up the leak detector.

The operating modes S and M should be selected via a micro selector switch located in the unit before the leak detector is started up. The current interstitial space pressure is indicated via a digital display which is integrated in the front panel. If the operating overpressure in the interstitial space drops to the selected alarm switching value then visual and acoustic alarms are automatically triggered.

Overpressure leak detector DLR-P..

With this variant of the device, the pressure in the interstitial space is generated by means of an integrated pump, as a result of which only dried ambient air is used as the leak detection medium. According to the technical description provided by the manufacturer, the lowest monitoring pressure is 1.45 bar and the highest interstitial space pressure is 3.4 bar. According to details provided by the manufacturer, special switching values are also possible.

Overpressure leak detector DLR-GS..

With this variant of the device, the overpressure in the interstitial space can only be generated by means of an externally connected pressure gas accumulator, whereby compressed air or inert gas can be used as the leak detection medium. Two types of the leak detector DLR-GS.. are manufactured. These two types differ in terms of the maximum operating pressure of the interstitial space. The DLR-GS 11 is designed for a maximum operating overpressure of 11 bar, while leak detector DLR- GS 22 is designed for a maximum operating pressure of 22 bar in the interstitial space. The alarm switching values are freely adjustable via an adjusting screw on the pressure switch and should be set beforehand in accordance with the operating instructions.

All variants of the device are equipped with a test connection which allows an external measuring device to be connected. Overpressure protection devices for protection of the devices and the interstitial spaces against violations of upper pressure limits are not a fixed part of the leak detector. Depending on the requirements, they can be connected in the device or externally to the interstitial space.

Details about the design of the leak detector DLR-.. can be found in the technical description provided by Sicherungsgerätebau GmbH dated 26 February 2002, and details about the design of the variant DLR-P.. can be found in the technical description dated 21 December 2005.

Test basis

- 4.1 Approval principles for leak detection systems for pipes (ZG-LAGR),
- 4.2 Building and testing principles for leak detection devices for pipes (TRbF 502),
- 4.3 Leak detection systems EN 13160.

Test documents/test specimens

- 5.1 Technical description of the overpressure leak detector DLR-.. dated 26.02.2002,
- 5.2 Prototype design of the leak detector, type DLR-G 3,
- 5.3 Test certificate for overpressure leak detector, type DLR-2, dated 21.06.95,
- 5.4 Technical description of overpressure leak detector DLR-P.. dated 21.12.2005

Tests

Design variant DLR-G 3 of the prototype design of the leak detector was tested for compliance with the requirements in EN 13160:2003 and in accordance with the approval principles for leak detection devices for containers and pipes. It was tested in conjunction with the technical description / design drawings and the current flow diagrams, as well as the installation and operating instructions and the software documentation.

The following individual tests were performed:

1. Testing of the electrical equipment (excluding explosion protection aspects)
2. Functional testing and switching operations at various threshold temperatures
3. Testing of the visual and acoustic alarm devices,
4. Pressure and leak testing of the fixtures

Operating mode S with an operating overpressure of 4.1 bar was chosen for the test.

7. Test results

Leak detector DLR-... complies with the requirements defined in EN 13160 and in the approval principles and building/test principles. The components of the sample device comply with the technical description and the drawings. The functional tests performed on the sample device of the leak detector of type DLV-G 3 have shown that the device can withstand the stresses and strains

and remains operational. The components of the electronic circuitry integrated in the device remain operational even under the temperature loads.

The outcome of mechanical function tests and software tests was positive. Undefined measured values, faulty calibration and failure of the system clock pulse all cause an alarm to be triggered. The leak detector of type DLR-... can comply with the requirements made of it in terms of monitoring the overpressure generated in the interstitial space and in terms of automatically generating an alarm when the alarm pressure threshold is reached.

The outcome of the alarm device tests was also positive. After 24 hours of continuous operation, the acoustic alarm device generated a noise level > 70 dB(A) at a distance of 1 m with the control cabinet closed. The visual alarm device was deemed to be adequate.

According to information supplied by the manufacturer, the pressure measuring sensor is pressure-resistant up to an overpressure of 30 bar, so no impairment of functionality is anticipated in higher pressure ranges.

The electrical installation in the fittings box is compliant with DIN VDE regulations. External forwarding of an alarm is ensured via the switching of a potential-free relay, whereby the device is protected against the circuit of the external alarm and through an interconnected additional fuse.

The leak detector with the type designation DLR-P... has the same design as the leak detector DL-... and, during the course of the approval process for obtaining General Building Authority Approval (*allgemeine bauaufsichtliche Zulassung* for Germany), it was already subjected to a suitability test. The leak detector DL.. has been granted General Building Authority Approval (*allgemeine bauaufsichtliche Zulassung* for Germany) for monitoring of double walled containers (approval no. Z.65.23-409). From the point of view of the testing body, there are no objections to the use of the leak detector for monitoring of double walled pipes within the constraints of the application parameters according to 3.1 and in accordance with the technical description for the leak detector DLR-P.. dated 21.12.2005. The leak detector is pressure resistant up to a pressure of 30 bar.

The leak detector with the type designation DLR-GS has the same design as the leak detector of type DLR-2, as a result of which its suitability has already been verified in the approval process. The leak detector DLR-2 has already been granted General Building Authority Approval (*allgemeine bauaufsichtliche Zulassung* for Germany) under the approval no. Z-65.26-304.

Assessment

The leak detector of type DLR-... has been approved as suitable as part of a leak indication device operating on the basis of overpressure, and it complies with the requirements of EN 13160 and the approval principles for leak detection devices for pipes and TRbF 502, provided the following conditions are met:

1. The leak detector variants, comprising the signal part and a pressure measuring device, are to be manufactured, adjusted and operated in accordance with the technical description dated 26.02.2002, or for the variant of type DLR-P.. in accordance with the technical description dated 21.12.2005.
2. The relevant detector type must only be used in the interstitial spaces specified in the "Area of use" section in the technical description. The alarm switching pressure of the leak detector should be adjusted in accordance with the technical descriptions, whereby the value must be at least 1 bar above the operating pressure of the pipe to be monitored.
3. The information provided by the manufacturer in the operating instructions must be observed in relation to establishing and maintaining the operating pressure of the leak detector. Every leak detector should be operated in such a way that the maximum permitted operating pressure of the interstitial space in the pipe and the components of the leak detector is not exceeded. In general, the only pressure reducers which should be used are those where the maximum adjustment range on the pressure reduction valve does not exceed the test pressure of the interstitial space. Otherwise, overpressure protection devices should be provided which prevent the maximum permitted operating pressure of the interstitial space from being exceeded.
4. If the leak detector is connected to interstitial spaces of overground pipes or pipes with flammable liquids (flash point < 55 °C), then fixed connecting lines should be provided which comply at least with pressure level PN 10. Before being taken into operation, the connecting pipes should be subjected to a pressure test at a pressure of at least 1.1x the operating pressure of the leak detector (no less than 5 bar).
5. The supply pressure for the pressure accumulator indicated in the technical description must be met, as otherwise the feed quantity of the leak detection medium will deviate from the value permitted according to the approval principles.
6. Every leak detector is to be permanently and legibly marked with at least the following information:

Manufacturer's name or manufacturer's symbol/logo,

Year of manufacture,
Production no.,
Approval cert. no.,
Type designation,
Rated operating data.

5. Every leak detector is to be subjected to a routine check prior to delivery. In terms of production monitoring, the requirements in EN 13160-1, Annex C, of TRbF 502 and/or ZG-LAGR no. 7 are to be observed.
6. Installation and operating instructions and a copy of the approval certificate must be enclosed with every leak detector.
7. For operation of the leak detector without a pressure controlled feed (operating mode M), a pressure accumulator should be permanently connected to the leak detector if a pressure increase up to the alarm switching point occurs within a year in the interstitial space due to leaks which cannot be located, e.g. gas pores. The operating mode should be changed on the device in accordance with the adjustment information in the technical description.

Note

Compliance with requirements relating to explosion protection, electromagnetic compatibility and the low voltage directive are not covered by the scope of these tests.

Straube
Specialist expert of
TÜV NORD GmbH & Co. KG
Testing body for leak detection devices

Technical report No. 713011930
Amendment 0
of 06.09.2012

More safety.
More value.

Customer: SGB GmbH
Mr. Martin Hücking
Hofstraße 10
57076 Siegen

Manufacturing location: Generant Company
1865 Route 23 South
PO Box 768
Butler, NJ 07405

Object of the assessment: Product: Poppet check valve
type: ICV

Test specification: EN 13463-1:2009

Aim of the assessment: Assessment of the above product with regard to ignition sources and suitability as a zone-separating measure between hazardous explosive areas zone 1 → zone 2

Test result: The test results show that the tested product does not have any potential ignition sources and thus falls under the area of application of Directive 94/9/EC. When used for its proper use the product can be regarded as a zone-separating measure.

This technical report can only be reproduced completely with the exact same wording. It must not be used for commercial purposes without written permission. It contains the result of a one-off inspection carried out on the product provided for testing and does not represent a general assessment of the properties of current manufacturing.

File name:
TB713011930.docx

Report number: 713011930
Amendment: 0
Created by: Sebastian Willer
Date created: 06.09.2012

Telephone: +49 711 7005-526
Fax: +49 89 5155-1899
Mobile: +49 1603602667
e-mail: sebastian.willer@tuev-sued.de
TÜV ®

TÜV SÜD Product Service GmbH
Niederlassung Stuttgart
Gottlieb-Daimler-Straße 7
70794 Filderstadt
Germany

1 Product description

1.1 Function

Manufacturer's information on proper use:

The poppet check valve is used as a component of an overpressure leak detection system. It is connected in a pneumatic tube between the manifold and the solenoid valve / leak detector. The poppet check valve is used to reduce zone 1 to zone 2

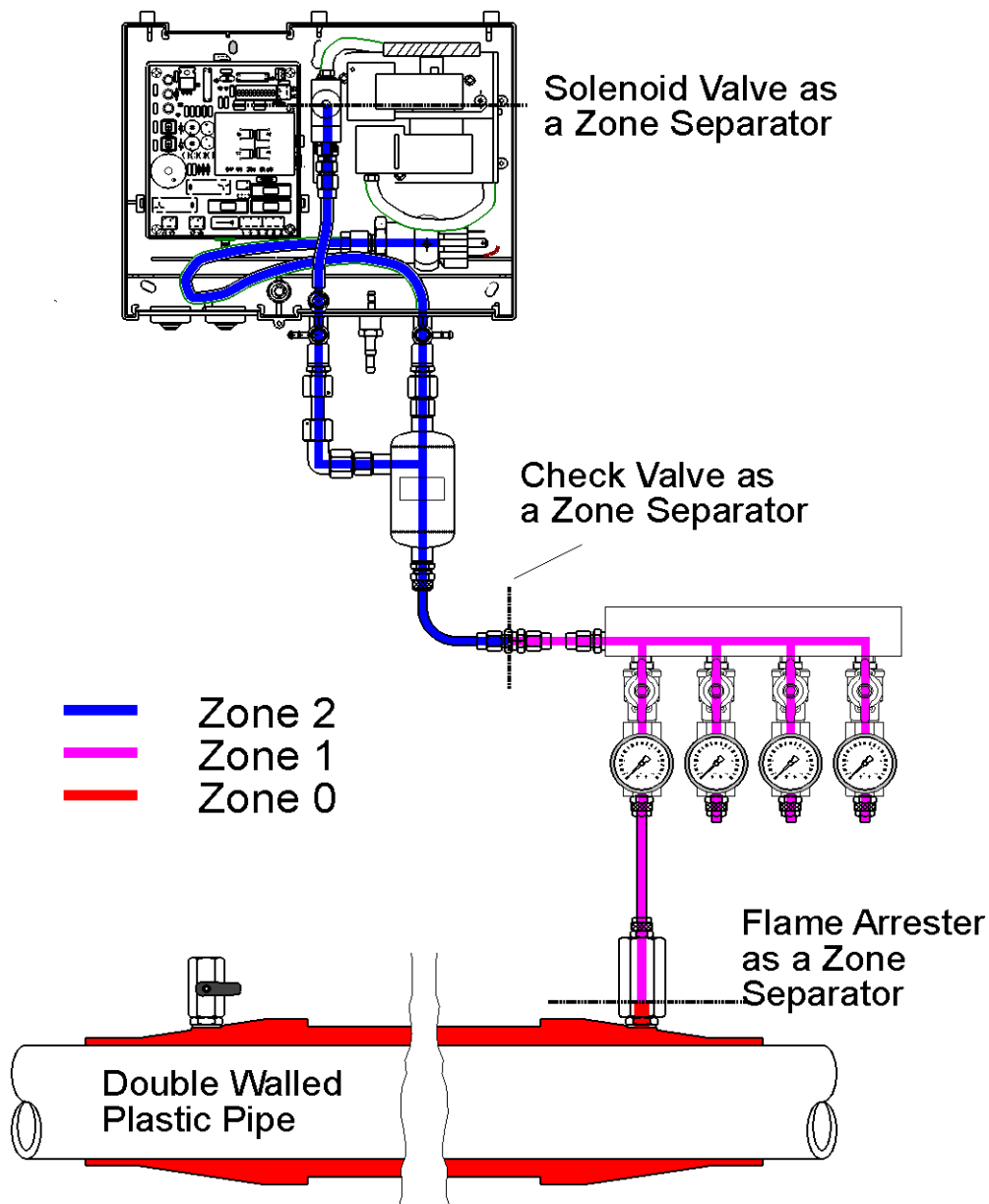

File name:
TB713011930.docx
Report number:
713011930
Amendment: 0

Created by:
Sebastian Willer
Date created:
06.09.2012

Telephone: +49 711 7005-526
Fax: +49 89 5155-1899
Mobile: +49 1603602667
e-mail: sebastian.willer@tuev-sued.de
TÜV®

TÜV SÜD Product Service GmbH
Niederlassung Stuttgart
Gottlieb-Daimler-Straße 7
70794 Filderstadt
Germany

1.2 Technical data

Nominal opening pressure:	0.01, 0.07 & 0.21 bar 83 bar
Testing pressure:	Vacuum up to 55 bar
Operating pressure range:	Zero at > 0.03 bar pressure difference
Leakage: Ambient temperature:	-62°C to 190°C

Component	Valve body material	
	Brass	Stainless steel ¹
Body, poppet	Brass, ASTM B16	316SS, ASTM A479
Spring retainer	Brass, ASTM B16 ²	316SS, ASTM A479
Spring	302 SS, ASTM A313	
O-ring ³	Buna-N	Viton™
Retaining ring	Zinc plated carbon steel	Stainless steel

¹ Stainless available in 1/8", 1/4", 3/8" & 1/2" male x male only

² 1/8" & 1/4" brass valves have 316SS retainer

³ Lubricated with Krytox™ GPL-202

2 Order

2.1 Date of order, customer's reference

05.09.2012

2.2 Receipt of test sample, location

21.08.2012

3 Test results

The assessment established that the product does not have any potential ignition sources and, when used for its proper use, is suitable as a zone-separating measure.

4 Comment

Proper use of the product as stipulated by the manufacturer must be adhered to.

All conductive parts must be connected to each other by a conductive connection. The bleeder resistance must be $\leq 106 \Omega$

File name:
TB713011930.docx

Report number:
713011930

Amendment: 0

Created by:
Sebastian Willer
Date created:
06.09.2012

Telephone: +49 711 7005-526
Fax: +49 89 5155-1899
Mobile: +49 1603602667
e-mail: sebastian.willer@tuev-sued.de
TÜV®

TÜV SÜD Product Service GmbH
Niederlassung Stuttgart
Gottlieb-Daimler-Straße 7
70794 Filderstadt
Germany

In order to ensure the product can continue to be used safely and reliably, an annual functional check and tightness test must be performed. Also, Viton material must be used for the O-ring.

The operating instructions have been checked as per the minimum requirements as described in the product standard. The manufacturer is responsible for the correctness of further content, the structure and layout.

5 Documentation

- Assessment of the overpressure leak detector (SGB GmbH)
- Poppet check valve data sheet (Generant Company)
- Ignition hazard assessment (TÜV SÜD Product Service GmbH)

6 Summary

The test results show that the tested product does not have any potential ignition sources and thus falls under the area of application of Directive 94/9/EC. Marking and a declaration of conformity as per Directive 94/9/EC is thus not permitted.

When used for its proper use the product can be regarded as a zone-separating measure.

TÜV SÜD Product Service GmbH

TÜV SÜD Product Service GmbH

Technical report inspected

Tester

Michael Reuschel (Signature)

Sebastian Willer (Signature)

Branchenkompetenzzentrum
Maschinen und Industrieprodukte

Branchenkompetenzzentrum
Maschinen und Industrieprodukte

File name:
TB713011930.docx

Report number:
713011930

Amendment: 0

Created by:
Sebastian Willer
Date created:
06.09.2012

Telephone: +49 711 7005-526
Fax: +49 89 5155-1899
Mobile: +49 1603602667
e-mail: sebastian.willer@tuev-sued.de
TÜV ®

TÜV SÜD Product Service GmbH
Niederlassung Stuttgart
Gottlieb-Daimler-Straße 7
70794 Filderstadt
Germany

Warranty

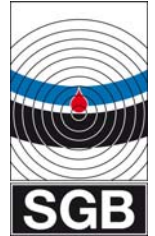

Dear customer,

You have purchased a high-quality leak detector from our company.

All of our leak detectors undergo a 100% quality control examination.

The type plate with the serial number is only affixed after all test criteria have been complied with.

The **warranty period** for our leak detectors is **24 months**, beginning on the date of installation on site.

The maximum warranty period is 27 months from our date of sale.

Our warranty will be effective only if the customer submits to us the functional report or test report on initial putting into service, prepared by a recognised company specialised in water and water protection systems, including the serial number of the leak detector.

Our warranty shall not apply in the event of faulty or improper installation or improper operation, or if modifications or repairs are carried out without the manufacturer's consent.

In case of malfunction, please contact your local specialist company:

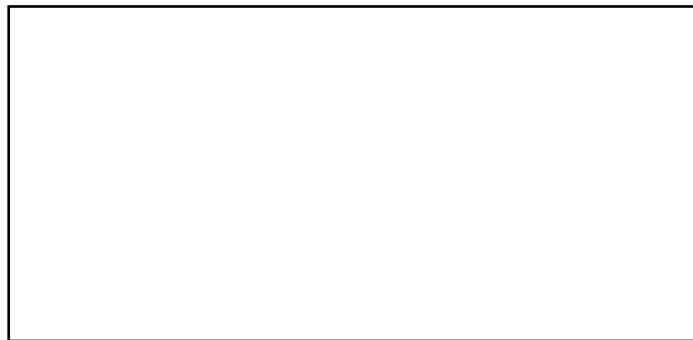

Stamp of the specialist company

Yours sincerely

SGB GmbH

Hofstraße 10
57076 Siegen
Germany

 +49 271 48964-0
fax: +49 271 48964-6
e-mail: sgb@sgb.de
web: www.sgb.de
